

6m x 14m Marquee

I
Select a flat ground for the tent, unpack the carton and check all the parts including tubes, tent and accessories... etc. are present.
Assemble the rooftop framework by joining the Connectors (6,7,8,9,10,11) together with poles (1,2). Ensure the tension screw is fixed to every pole tightly.
And then attach one strengthen bar (4.5) to the frame by screw.
Ensure poles are fully inserted into connectors in order to achieve the correct overall structure dimension.

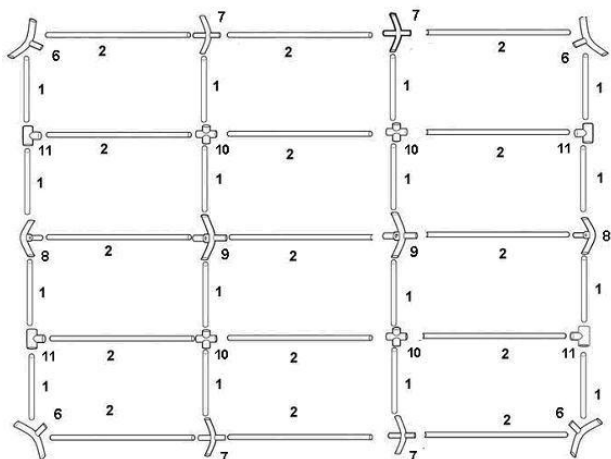

Model shown is 6x6m tent. Simply increase or reduce to the desired length by adding or reducing 2 metre bays using parts 1,2,7,9 and 10.

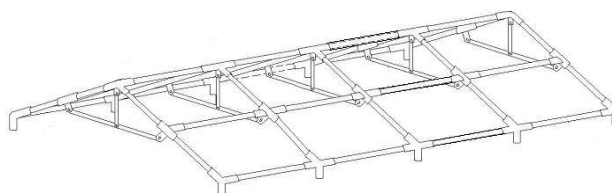

II
Attach one end of supported pole (3) to the joints (6,7)

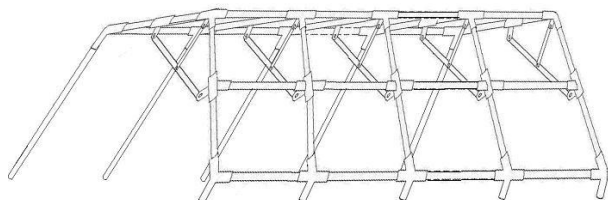

III
Place roof cover on frame, and attach with bungee fixings, take care not to over tension bungee, as this may cause difficulty correctly fitting roof.

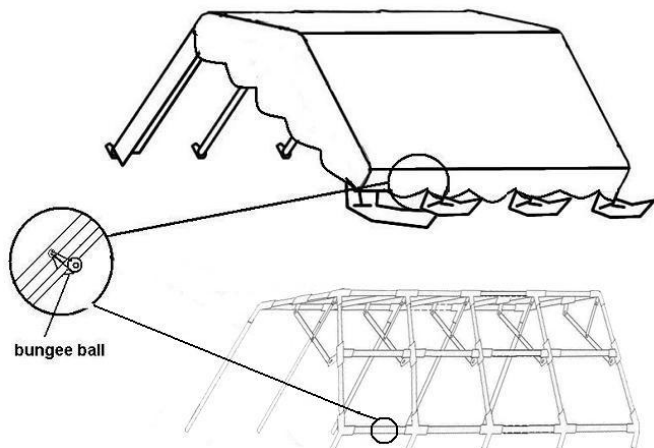

6m x 14m Marquee

IV
Attach the other supported poles (3) to the joints (6,7), built-up the framework. Attach the foot bases to supporting poles. Use the medium peg to fix each pole into the ground and use the hook to fix the leg cover to the leg.

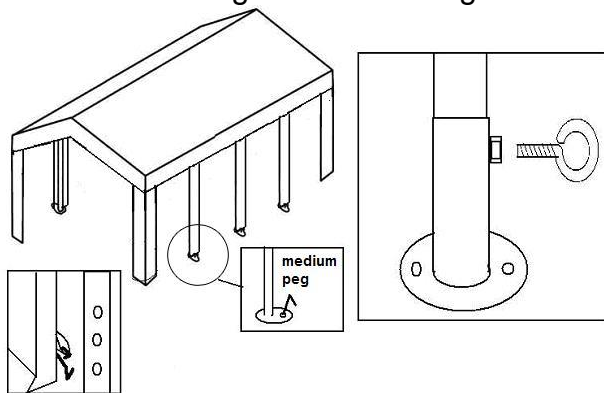

V
Spread the wall and door panels, and attach to framework using the bungee cords. Clasp the frame to the metal eyelets (located over the wall and door panels) to ensure stability. Also use the short pegs to fix the doors and walls to the ground.

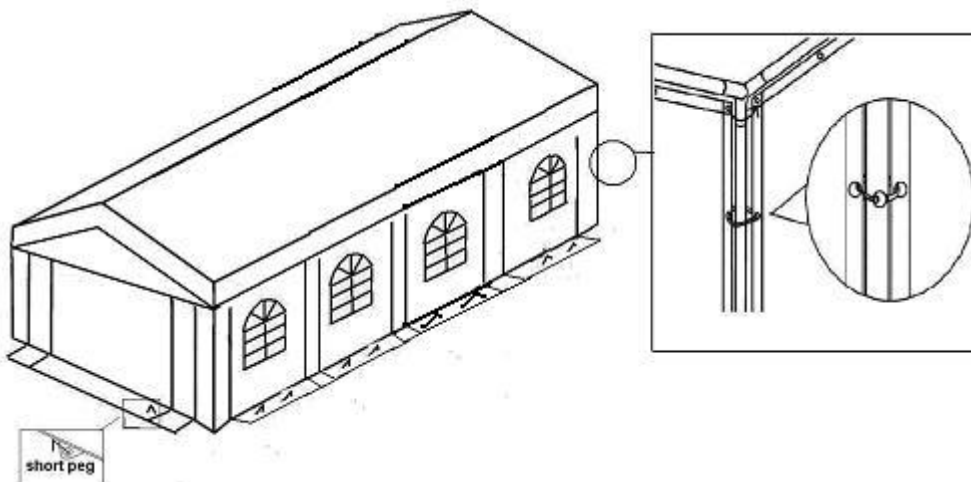

VI
Attach Guy ropes to all corners of tent and fix to ground using spiral pegs.

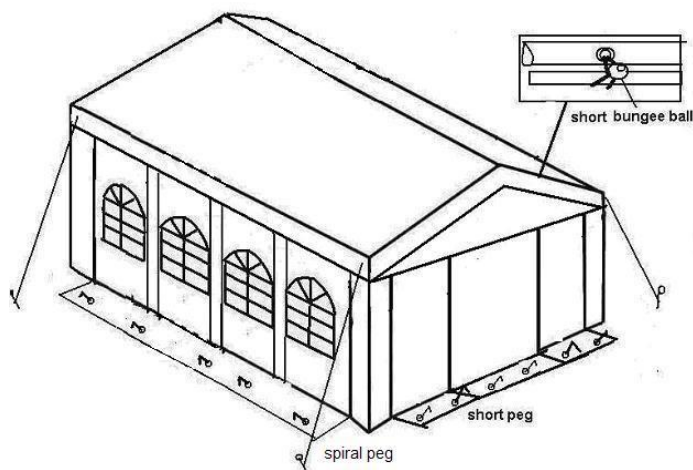

6m x 14m Marquee



Warning

1. Take note that the tent needs to be handled carefully to avoid damage.
2. Do not force the frame, as there may be damage in the process.
3. Tents are meant as temporary shelter and must be evacuated under extreme weather conditions.
4. Please select a suitable site for the tent to avoid damage to underground sprinkler systems, water, gas or electrical lines.
5. Whilst this product is Fire retardant care should be taken. Keep away from naked flame and other heat sources.

All images used are for illustration purposes only and may not represent an individual product.